

1047-1083

Elongated Front, SmartHeight™ Vitreous China, Two-Piece Toilet

FEATURES

- 2-bolt tank-to-bowl connection
- 1.28 gpf / 4.8 lpf high efficiency water consumption (HET)
- Elongated front SmartHeight™ bowl
- 3" flush valve
- Anti-siphon pilot fill valve
- 12" rough-in
- Model 83 chrome-plated, plastic trip lever with brass arm
- 2" trapway
- One-year warranty on vitreous china and tank trim
- Available in White



MODEL 1047-1083

Toilet seat not included





ELONGATED



SMARTHEIGHT ADA

COMPONENTS



MODEL #	DESCRIPTION	CODES/STANDARDS
1047-1083	Elongated front, SmartHeight™ two-piece toilet.	  
1047	Elongated front, SmartHeight™ toilet bowl only. Less toilet seat.	
1083	Tank and cover only with left hand, front-mount, chrome-plated, plastic trip lever and anti-siphon pilot fill valve. Less supply.	

TANK TRIM & REPLACEMENT PARTS	
83	Trip lever - chrome-plated, plastic trip lever, left hand
283	3" Flush valve
90	Anti-siphon pilot fill valve

1047-1083

Elongated Front, SmartHeight™ Vitreous China, Two-Piece Toilet

SPECIFICATIONS

MODEL #	DESCRIPTION	CODES/STANDARDS
1047-1083	Elongated front, SmartHeight™ (1.28 gpf / 4.8 lpf) two-piece toilet	  

MATERIAL	Vitreous China	TRAP DIAMETER	2'
WATER PRESSURE RANGE	20 to 80 PSI	TRAP SEAL	2-1/4'
FLUSH SYSTEM	3" Flush Valve	SHIPPING WEIGHT	Model 1047 - 47.4 lbs. (21.5 kg) Model 1083 - 28.6 lbs. (13 kg)
WATER USAGE	1.28 gpf / 4.8 lpf	WARRANTY	Vitreous China - Limited One Year Tank Trim - Limited One Year
WATER SURFACE AREA	6' X 7'		
ROUGH-IN	12'		
MAP RATING	800 grams		

TECHNICAL INFORMATION

Note: these dimensions are nominal and subject to change without notice.

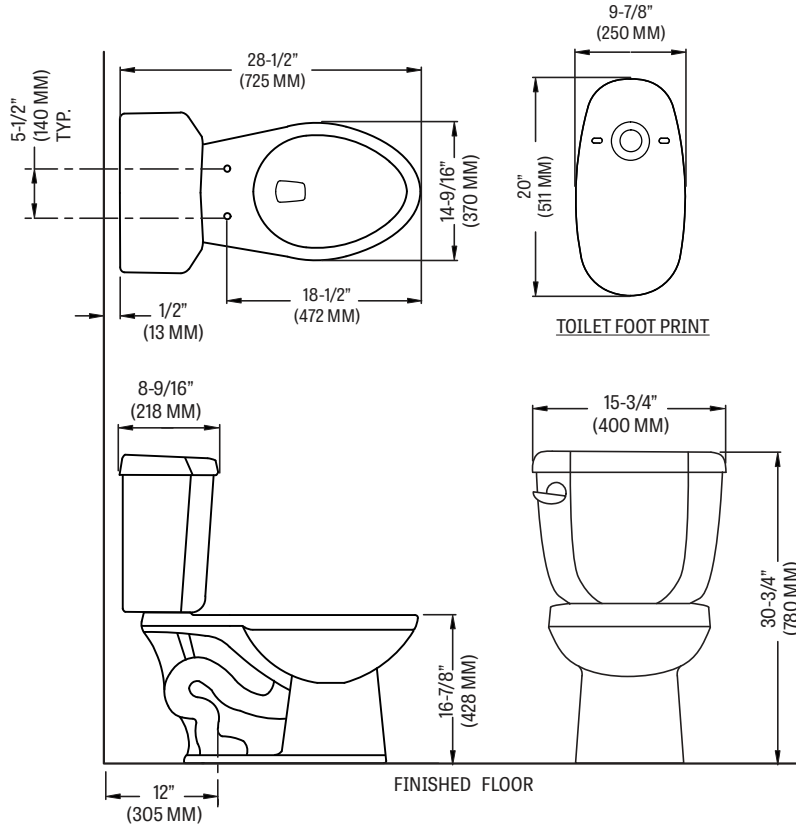

Fixture performance and specifications meet or exceed ASME A112.19.2/CSA B45.1 standards, and other state and local codes.